

Controleer op tekenen van plotselinge hartstilstand:

Niet reageert Niet normaal ademt

1. TREKKEN

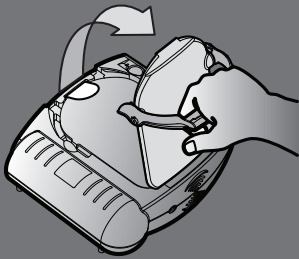

2. AANBRENGEN

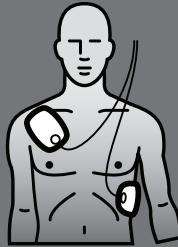

3. DRUKKEN

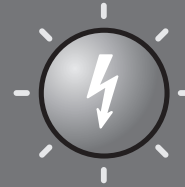

BEKNOPTE NASLAGGIDS



BEKNOPTE NASLAGGIDS

Gedetailleerde Aanwijzingen



Te starten: Trek aan handvat. Verwijder deksel.

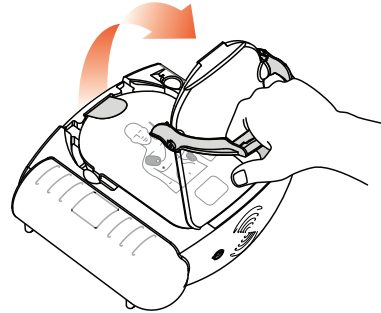
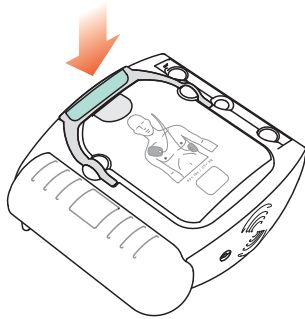

Verwijder de kleding van de borst van de patiënt.
Maak de huid schoon en droog deze zo nodig af.

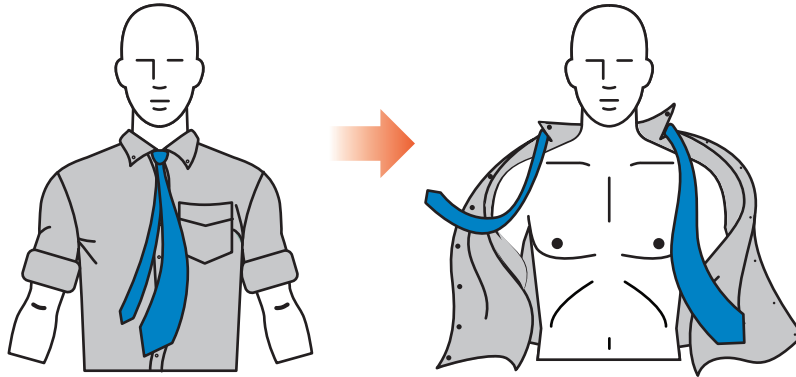

2

Trek het beschermfolie los en need de elektroden uit.

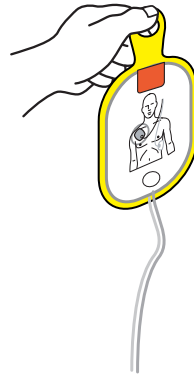
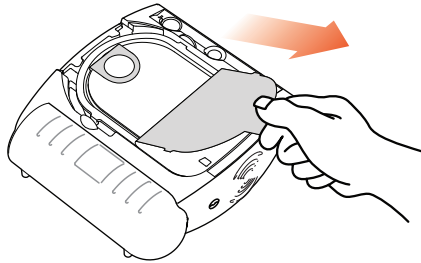

Trek de elektroden van de gele kunststof onderlaag.

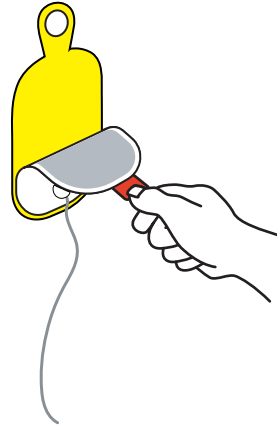
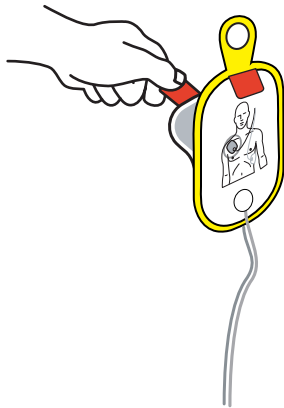

Breng de elektroden precies zo aan als op de plaatjes.

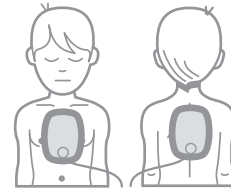
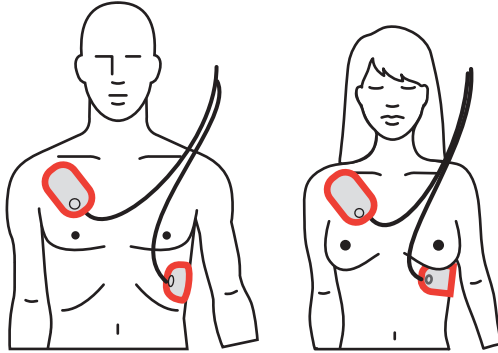

(0-8 jaar) < 25 kg

Analyse in uitvoering ... Raak de patiënt niet aan!

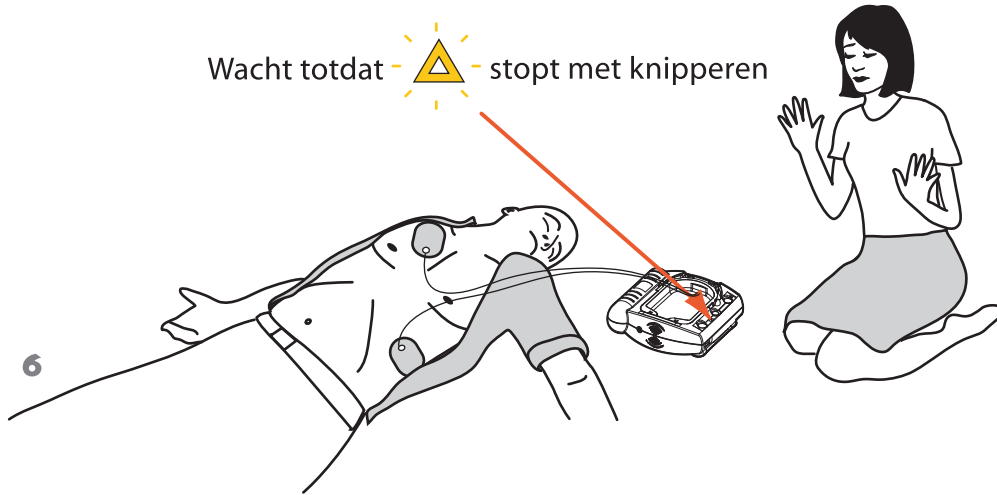

Om een shock toe te dienen: Druk op de knipperende oranje schoktoets. Raak de patiënt niet aan.

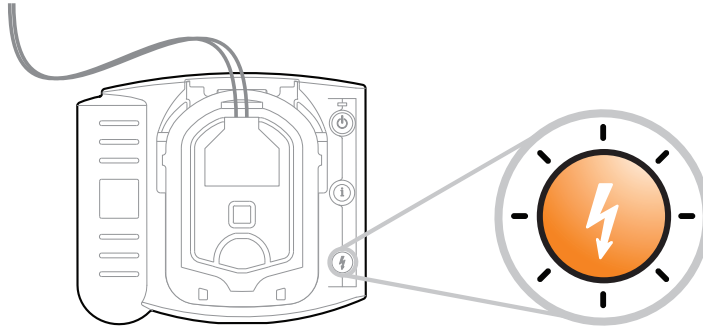

Voor hulp bij reanimatie:
Druk op knipperende blauwe knop.

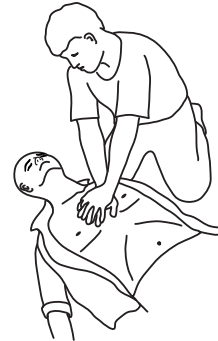
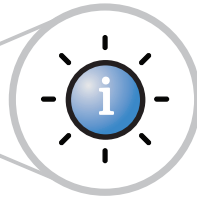
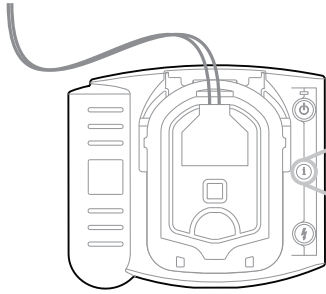

8 Knijp neus dicht, kantel hoofd achterover • voer 30 compressies uit • beadem tweemaal vol

Als de cassette vervangen moet worden:
Verschuif de vergrendeling.

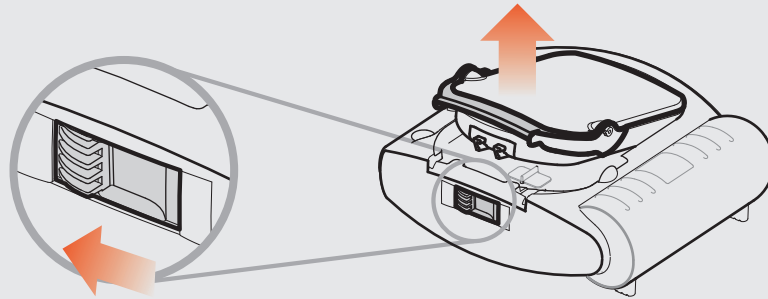

Gedrukt in de VS

Philips Medical Systems
Seattle, WA 98121

Copyright © 2006
Philips Electronics North American Corp

M 5 0 6 6 - 9 7 8 0 3



0 1 1 9 8 2 - 0 0 0 4

PHILIPS